

## CMIP3C42W-28MDA

### 4 MP Full Color Fixed Turret Network Camera



The camera provides 24/7 vivid colorful images with F1.0 advanced lenses and high performance sensors. F1.0 super-aperture collects more light to produce brighter images. Advanced sensor technology can vastly improve the utilization of available light.

- High quality imaging with 4 MP resolution
- Efficient H.265+ compression technology
- Clear imaging against strong backlight due to 130 dB WDR technology
- Built-in microphone for real-time audio security
- Focus on human and vehicle targets classification based on deep learning
- 24/7 colorful imaging
- Water and dust resistant (IP67)

## ▪ Specification

<b>Camera</b>	
Image Sensor	1/1.8" Progressive Scan CMOS
Min. Illumination	Color: 0.0005 Lux @ (F1.0, AGC ON), B/W: 0 Lux with white light
Shutter Speed	1/3 s to 1/100,000 s
Slow Shutter	Yes
P/N	P/N
Wide Dynamic Range	130 dB
Angle Adjustment	Pan: 0° to 360°, tilt: 0° to 75°, rotate: 0° to 360°
<b>Lens</b>	
Lens Type	Fixed focal lens, 2.8 mm optional
Iris Type	Fixed
Lens Type & FOV	2.8 mm, horizontal FOV 112°, vertical FOV 61°, diagonal FOV 134°
Depth of Focus	2.8 mm, 2.5 m to ∞
Aperture	F1.0
Lens Mount	M16
<b>DORI</b>	
DORI	2.8 mm, D: 58 m, O: 23 m, R: 11 m, I: 2 m
<b>Illuminator</b>	
Supplement Light Type	White Light
White Light Range	98ft(30 m)
Smart Supplement Light	Yes
<b>Video</b>	
Max. Resolution	2688 × 1520
Main Stream	50 Hz: 25 fps (2688 × 1520, 1920 × 1080, 1280 × 720) 60 Hz: 30 fps (2688 × 1520, 1920 × 1080, 1280 × 720)
Sub Stream	50 Hz: 25 fps (640 × 480, 640 × 360) 60 Hz: 30 fps (640 × 480, 640 × 360)
Third Stream	50 Hz: 10 fps (1920 × 1080, 1280 × 720, 640 × 480, 640 × 360) 60 Hz: 10 fps (1920 × 1080, 1280 × 720, 640 × 480, 640 × 360) *Third stream is supported under certain settings.
Video Compression	Main stream: H.265/H.264/H.265+/H.264+ Sub-stream: H.265/H.264/MJPEG Third stream: H.265/H.264 *Third stream is supported under certain settings.
Video Bit Rate	32 Kbps to 8 Mbps
H.264 Type	Baseline Profile/Main Profile/High Profile
H.265 Type	Main Profile
H.264+	Main Stream supports
H.265+	Main stream supports
Bit Rate Control	CBR/VBR
Scalable Video Coding (SVC)	H.264 and H.265 encoding
Region of Interest (ROI)	1 fixed region for main stream and sub-stream
<b>Audio</b>	
Environment Noise Filtering	Yes

Audio Sampling Rate	8 kHz/16 kHz/32 kHz/44.1 kHz/48 kHz
Audio Compression	G.711ulaw/G.711alaw/G.722.1/G.726/MP2L2/PCM/MP3/AAC
Audio Bit Rate	64 Kbps (G.711ulaw/G.711alaw)/16 Kbps (G.722.1)/16 Kbps (G.726)/32 to 192 Kbps (MP2L2)/8 to 320 Kbps (MP3)/16 to 64 Kbps (AAC)
<b>Network</b>	
Simultaneous Live View	Up to 6 channels
API	Open Network Video Interface (PROFILE S, PROFILE G, PROFILE T), ISAPI, SDK
Protocols	TCP/IP, ICMP, HTTP, HTTPS, FTP, DHCP, DNS, DDNS, RTP, RTSP, NTP, UPnP, SMTP, IGMP, 802.1X, QoS, IPv4, IPv6, UDP, Bonjour, SSL/TLS, PPPoE, SNMP, ARP
User/Host	Up to 32 users. 3 user levels: administrator, operator and user
Security	Password protection, complicated password, HTTPS encryption, IP address filter, Security Audit Log, basic and digest authentication for HTTP/HTTPS, TLS 1.1/1.2, WSSE and digest authentication for Open Network Video Interface
Network Storage	MicroSD/SDHC/SDXC card (256 GB) local storage, and NAS (NFS, SMB/CIFS), auto network replenishment (ANR)
Web Browser	Plug-in required live view: IE 10+ Plug-in free live view: Chrome 57.0+, Firefox 52.0+ Local service: Chrome 57.0+, Firefox 52.0+
<b>Image</b>	
SNR	≥ 52 dB
Day/Night Switch	Auto, Schedule
Image Enhancement	BLC, HLC, 3D DNR
Image Parameters Switch	Yes
Image Settings	Rotate mode, saturation, brightness, contrast, sharpness, gain, white balance adjustable by client software or web browser
<b>Interface</b>	
Built-in Microphone	Yes
On-board Storage	Built-in micro SD/SDHC/SDXC slot, up to 256 GB
Hardware Reset	Yes
Communication Interface	1 RJ45 10 M/100 M self-adaptive Ethernet port
<b>Event</b>	
Basic Event	Motion detection (human and vehicle targets classification), video tampering alarm, exception
Smart Event	Scene change detection
<b>Deep Learning Function</b>	
Face Capture	Yes
Perimeter Protection	Line crossing detection, intrusion detection, region entrance detection, region exiting detection
<b>General</b>	
Linkage Method	Upload to NAS/memory card/FTP, notify surveillance center, trigger recording, trigger capture, send email





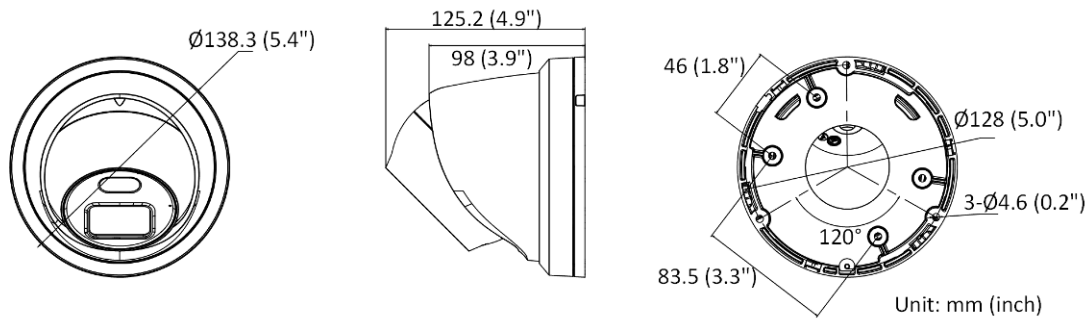



Web Client Language	33 languages English, Russian, Estonian, Bulgarian, Hungarian, Greek, German, Italian, Czech, Slovak, French, Polish, Dutch, Portuguese, Spanish, Romanian, Danish, Swedish, Norwegian, Finnish, Croatian, Slovenian, Serbian, Turkish, Korean, Traditional Chinese, Thai, Vietnamese, Japanese, Latvian, Lithuanian, Portuguese (Brazil), Ukrainian
General Function	Anti-flicker, heartbeat, mirror, privacy mask, flash log, password reset via email, pixel counter
Software Reset	Yes
Storage Conditions	-30 °C to 60 °C (-22 °F to 140 °F). Humidity 95% or less (non-condensing)
Startup and Operating Conditions	-30 °C to 60 °C (-22 °F to 140 °F). Humidity 95% or less (non-condensing)
Power Supply	12 VDC ± 25%, reverse polarity protection PoE: 802.3af, Class 3
Power Consumption and Current	12 VDC, 0.55 A, max. 6.6 W PoE (802.3af, 36 V to 57 V), 0.22 A to 0.13 A, max. 7.6 W
Power Interface	Ø5.5 mm coaxial power plug
Material	Aluminum alloy body, except for trim ring
Screw Material	SUS304
Camera Dimension	Ø138.3 mm × 125.2 mm (Ø5.4" × 4.9")
Package Dimension	170 mm × 170 mm × 150 mm (7" × 7" × 5.9")
Camera Weight	Approx. 750 g (1.7 lb.)
With Package Weight	Approx. 1055 g (2.3 lb.)
<b>Approval</b>	
EMC	FCC SDoC (47 CFR Part 15, Subpart B); CE-EMC (EN 55032: 2015, EN 61000-3-2: 2014, EN 61000-3-3: 2013, EN 50130-4: 2011 +A1: 2014); RCM (AS/NZS CISPR 32: 2015); IC VoC (ICES-003: Issue 6, 2016); KC (KN 32: 2015, KN 35: 2015)
Safety	UL (UL 60950-1); CB (IEC 60950-1:2005 + Am 1:2009 + Am 2:2013, IEC 62368-1:2014); CE-LVD (EN 60950-1:2005 + Am 1:2009 + Am 2:2013, IEC 62368-1:2014); BIS (IS 13252(Part 1):2010+A1:2013+A2:2015); LOA (IEC/EN 60950-1)
Environment	CE-RoHS (2011/65/EU); WEEE (2012/19/EU); Reach (Regulation (EC) No 1907/2006)
Protection	IP67 (IEC 60529-2013)

▪ Dimension

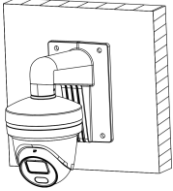

▪ Accessory

▪ Optional

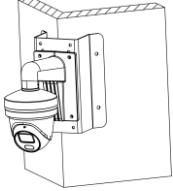
LTB342-140B Wall Mount	LTB342-140 Wall Mount	LTB378 Vertical Pole Mount	LTB701-A Junction Box	LTB379 Corner Mount
				
				
<b>LTB341 Pendant Mount</b>				
