

# LTB742-120B

## Wall Mounting Bracket for Mini Dome Camera (with Junction Box)



### Features:

- Aluminum alloy material with surface spray treatment
- The outlet hole makes the feature looks better
- Better water proof design
- The matched junction box has the waterproof pad

### Dimension:

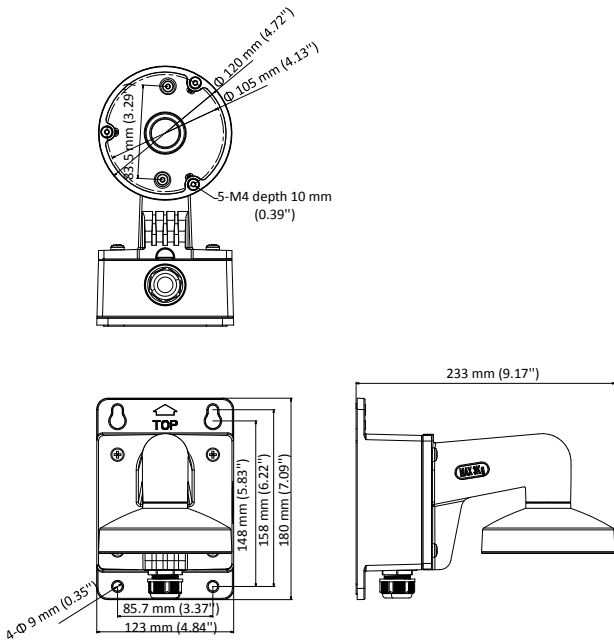

### Parameter:

Model	LTB742-120B
Parameters	Wall Mounting Bracket for Mini Dome Camera (with Junction Box)
Appearance	White
Range of Application	Suitable for dome camera wall mounting
Material	Aluminum Alloy
Dimension	123 × 180 × 233 mm
Weight	1200 g (2.65 lb.)

### Notice:

- Pay attention to the color matching when select bracket.
- The bracket should be installed on flat wall.
- The waterproof pad has to be kept when installing.
- The wall must be capable of supporting over 3 times as much as the total weight of the camera and the mount.
- The maximum load capacity of the bracket is 3 kg.



**Installation Step:**

- ① Choose the appropriate wall and thread the wire through the waterproof stopper

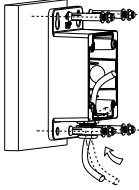

- ② Fix the bracket to junction box, thread the wire and screw up

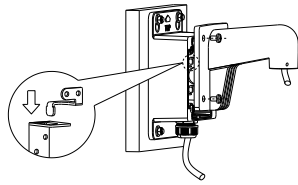

- ③ Install the bowl to the bracket and fix with fastening screw

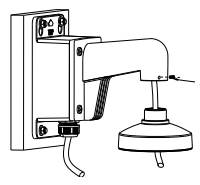

- ④ Get off the transparent cover and check the hole site of adapter plate

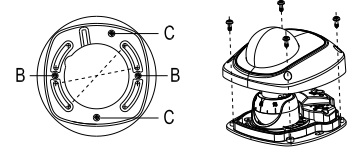

- ⑤ Install the combination to the bracket and complete the installation

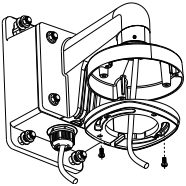

- ⑥ Connect the camera wire and fix the camera onto the adapter plate

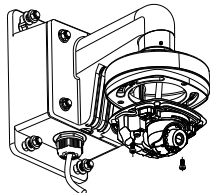

- ⑦ Modify the angle of monitoring, install the transparent cover and screw up

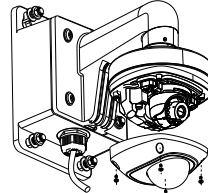

- ⑧ Bracket Installation complete.

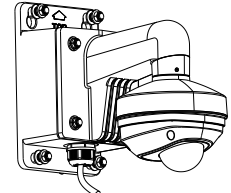

**Note:** The actual bracket may vary from the picture above.

